



EXPERIMENTAL INVESTIGATION OF STEEL EQUAL ANGLE SUBJECTED TO COMPRESSION

Jyoti V. BHILAWE, Laxmikant M. GUPTA

*Department of Applied Mechanics, Visvesvaraya National Institute of Technology,
Nagpur 440 010, India*

Received 14 August 2015; accepted 26 November 2015

Abstract. This paper presents pin-ended compression tests on steel equal angles. Three nominal section sizes were tested. Detailed measurements of material properties, residual stresses, and geometrical imperfections were conducted. The pin ended specimens were tested with a minimal eccentricity of $L/1,000$ applied about the minor axis to cause compression at the tips of the legs. The test data are compared with the Indian specifications for hot-rolled steel structures. The section capacities obtained from the column tests are found to be between 15 and 40% higher than those calculated according to the specifications. It is concluded that there is no need to include the additional eccentricity specified in the steel structures standards accounting for the shift of the effective centroid, and that the eccentricity of $L/1,000$, specified for all section classes, should be applied to slender sections only.

Keywords: angle, residual stress, imperfection, IS 800:2007, buckling, compression.

Introduction

Single-angle compression members are simple structural elements that are very difficult to analyze and design. These members are usually attached to other members by one leg only. Thus the load is applied eccentrically. To further complicate the problem the principal axes of the angle do not coincide with the axes of the frame or truss of which the angle is a part. Although it is known that the end conditions affect the ultimate load carrying capacity of these members. Procedures have not been developed to do this as it is difficult to evaluate the end restraint in many practical cases.

Yokoo *et al.* (1968) performed a study that included the testing of hot rolled single-angle members loaded concentrically in compression using a ball-joint connection. Kennedy and Murty (1972) presented a rational buckling analysis that was designed to overcome limitations in the American Institute of Steel

Construction (AISC) Specifications and the Canadian Standards Association (CSA) design code. As part of the testing program designed to verify the analytical buckling analysis, 72 single-angle struts were tested with ends both fixed and hinged. All angles were designed to fail in elastically, and actual dimensions and yield stresses were measured as part of the testing program. Kitipornchai and Lee (1984) reported an experimental investigation into the inelastic buckling of axially loaded pin-ended single angle, tee, and double angle struts. A total of 54 struts were tested, comprising of 13 single equal and unequal-leg angles (repeated twice), and 12 tee struts. An experimental investigation was carried on the buckling strength of structural steel angles; various eccentricities and slenderness ratios were included and the test results agreed with theoretical predictions. Yokoo, Wakabayashi, and Nonaka (1968) tested fifty-seven mild steel equal-leg angles under both concentric and eccentric axial load-

Corresponding author:

J. V. Bhilawe E-mail: jyoti.bhilawe@gmail.com

Copyright © 2015 Vilnius Gediminas Technical University (VGTU) Press

<http://www.tandfonline.com/TESTN>

ing. while the simple approach of neglecting the eccentricity by modifying the effective slenderness ratio can be either conservative (Adluri, Madugula 1992) or unconservative for some practical cases of design (Elgaaly *et al.* 1991; Aydin 2009; Temple, Sakla 1995; Liu, Hui 2008, 2010). Woolcock and Kitipornchai (1986) suggested a design procedure that uses the uniaxial beam-column interaction equation for designing of web compression members in trusses.

Different design practices were presented and evaluated using experimental test results obtained from previous research. The two generally accepted design procedures the simple-column and the beam-column approaches. In general, underestimate the load carrying capacity of single-angle compression members attached by one leg to a gusset plate. There is a great variation between different design practices in the prediction of the compressive resistance of single-angle members. With that great variation it is difficult to determine the most appropriate design procedure to follow.

This paper presents the results of hinged ended compression tests includes 12 one bolt, 6 two bolts and 6 welded end fixity considered test specimen performed for single equal angle section connected to gusset plate. The Indian Standard IS 800: 2007 has four design column curves corresponding to various types of sections and materials. The column curves are defined by the members section constant (α) ranging from 0.21 to 0.76. Curves with α equal 0.21, 0.34, and 0.49 without considering factor γ_{m0} correspond closely to the SSRC curves 1, 2, and 3, respectively. The specific objectives of this program are to test slender and non-slender equal angle columns, to compare the test results with the multiple column curves in IS 800: 2007.

1. Experimental program

1.1. Material properties test

1.1.1. Section size

Three different sizes of angles L 50×6, L 60×5, L 65×6 of various lengths were used to carry out experimental program. The specimen ID and nominal thicknesses of these three cross sections are shown in Table 1. An effective length Factor considered as 1.0 to predict the compressive resistance means that bolts were designed as if the angles were concentrically-loaded and pin-ended. This is a common design practice to assume an effective length factor and calculate the ultimate load carrying capacity of the compression member.

1.1.2. Tensile coupon tests

For each angle section, 2 tension coupons were prepared for the tension tests, to obtain the mechanical properties of the steel angles. The labels for the coupons signify the section size of angles where they were cut from. The following number represents the section size, and the last character of the label identifies the serial number of tension coupons with the same section size.

The dimensions of tension coupons and their cutting locations in the angle legs are all based on the Indian Standard tensile testing requirement (IS 2062:2006) are shown in Figure 1. The tension coupons are cut parallel to the rolling direction. The test is performed with TUE-C-N-1000 Universal Testing Machine (UTM). Experimental test set up for tensile test are shown in Figure 2. The stress-strain curves obtained from tension coupon for each section respectively. Sample data of stress-strain curve for test specimen are shown in Figure 3.

Table 1. Nominal dimension and tensile coupon test results

Specimen	Angle size (mm)	Actual Width (mm)	Actual Thick. (mm)	F _y (MPa)	F _u (MPa)	E (MPa)
Specimen 1						
S1A	L 50×6	19.72	5.94	349	487	1.98 × 10 ⁵
S1B	L 50×6	19.83	5.97	352	495	2.10 × 10 ⁵
Specimen 2						
S2A	L 60×5	21.92	4.32	349	487	1.90 × 10 ⁵
S2B	L 60×5	21.46	4.51	354	496	2.01 × 10 ⁵
Specimen 3						
S3A	L 65×6	22.40	6.12	348	489	2.03 × 10 ⁵
S3B	L 65×6	21.87	6.23	351	493	2.11 × 10 ⁵
Overall Average Values				350.5	491.167	2.01 × 10 ⁵

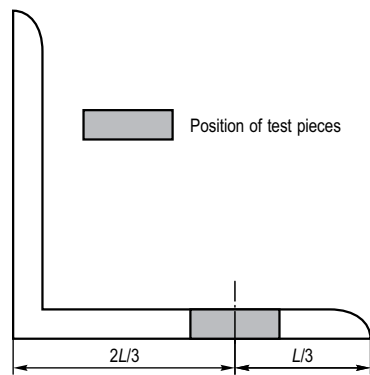

Fig. 1. Structural steel section, position and orientation of sample (IS 2062:2006)

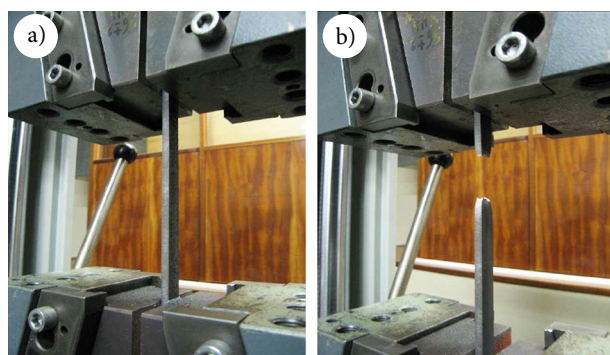

Fig. 2. Tensile coupons test: a) Tension test specimen; b) Tension specimen at end of test

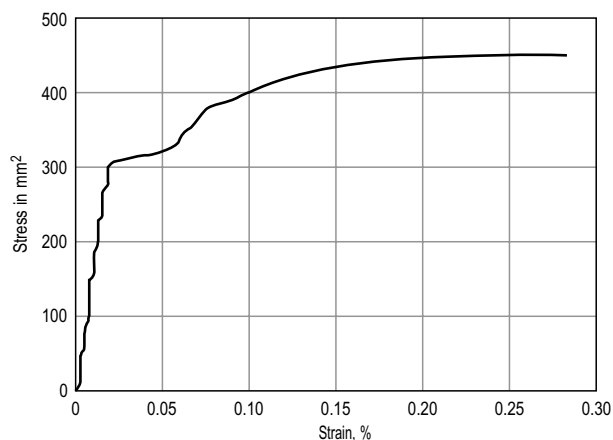

Fig. 3. Typical stress-strain curves of tensile coupons

The mechanical properties obtained from the tension coupon test are shown in Table 1, where F_y is the yield strength with an E value of 2.01×10^5 MPa, F_u is the ultimate strength. The overall average yield stress, $F_{y_{avg}}$, for material in the angles is 350.5 MPa and the average ultimate tensile strength, $F_{u_{avg}}$, is 491.167 MPa. It can be seen from the table that for all the steel angles, the measured values of the yield strength are

within the acceptable range of the Indian standard specification for mild steel, where the specified minimum yield stress is 350 MPa and the ultimate tensile stress range is 490 MPa.

1.2. Initial imperfections (out-of-straightness)

It is well-known that structural member is not perfectly straight, and that small initial imperfections can cause a significant drop in the concentric compressive strength of prismatic members. The effect of initial imperfections has been widely studied in the literature (e.g., BJORHOVDE 1972) and has been accounted for, directly or indirectly, in most current design specifications. Leg out-of-straightness measurements are shown in Figure 4.

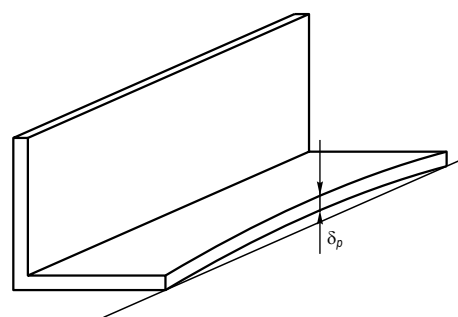

Fig. 4. Leg out-of-straightness measurements

In this investigation, the initial out-of-straightness of 42 steel angles is determined. The specimens for each angle size varied between 900 to 1800 mm in length. For equal-leg angles, the out-of-straightness is measured directly about the principal axes. All measurements were taken from a datum formed by nylon wires tightly stretched. The average value of maximum out-of-straightness for the 42 specimens used in the study is calculated to be $L/962$. The ratio of standard deviation to mean is 0.338. Initial out of straightness measurement result are summarized in Table 2.

Various authors have suggested the initial out of straightness measurement same has been used by design code. As per British Standard (BS 5950:2000), Clause no. 6.4.3 has given Member imperfections for a compression member, this equivalent initial bow imperfection are specified in Table 3. e_0 is the amplitude of the initial bow imperfection. Variation of the initial bow imperfection v_0 along the member length is given by, $v_0 = e_0 \sin \pi x/L$, L is the member length; x is the distance along the member.

Table 2. Initial out-of-straightness of test specimens

No.	Angle size	Specimen ID	L (mm)	δp (mm)	$L/\delta p$
1	L50×5	S1A	900	1.5	1/600
2	L50×5	S1B	1200	2.5	1/480
3	L50×5	S1C	1400	1	1/1400
4	L50×6	S2A	1000	2	1/500
5	L50×6	S2B	1300	1	1/1300
6	L50×6	S2C	1500	2	1/750
7	L60×5	S3A	1100	1	1/1100
8	L60×5	S3B	1400	2	1/700
9	L60×5	S3C	1600	1	1/1600
10	L65×6	S4A	1200	1.5	1/800
11	L65×6	S4B	1500	2.5	1/600
12	L65×6	S4C	1800	1.5	1/1200
13	L50×5	S5A	800	1	1/800
14	L50×5	S5B	1200	1.5	1/800
15	L50×5	S5C	1500	1	1/1500
16	L50×6	S6A	1000	2	1/500
17	L50×6	S6B	1300	2.5	1/520
18	L50×6	S6C	1500	1.5	1/1000
19	L50×5	S7A	1100	1.2	1/917
20	L50×5	S7B	1400	1.8	1/778
21	L50×5	S7C	1600	1.5	1/1066
22	L50×6	S8A	1200	2	1/600
23	L50×6	S8B	1500	1.5	1/1000
24	L50×6	S8C	1800	1.5	1/1200
25	L60×6	S9A	1500	1	1/1500
26	L60×6	S9B	1500	2	1/750
27	L60×5	S10A	1500	1.5	1/1000
28	L60×5	S10B	1500	1	1/1500
29	L60×5	S11A	1500	1.2	1/1250
30	L60×6	S11B	1500	2	1/750
31	L60×6	S12A	1500	1.5	1/1000
32	L60×6	S12B	1500	1	1/1500
33	L60×6	S13A	1500	1.5	1/1000
34	L60×6	S13B	1500	2	1/750
35	L60×6	S14A	1500	2.5	1/600
36	L60×6	S14B	1500	1	1/1500
37	L65×6	S15A	1500	1.2	1/1250
38	L65×6	S15B	1500	1.8	1/833
39	L65×6	S16A	1200	1.3	1/923
40	L65×6	S16B	1200	2	1/600
41	L65×6	S17A	1200	1	1/1200
42	L65×6	S17B	1200	1.5	1/800
Average value					1/962

Table 3. Values of member initial bow imperfection

Buckling curves	e_0/L used in Second-order P- Δ - δ elastic analysis
a_0	1/550
a	1/500
b	1/400
c	1/300
d	1/200

According to Perry-Robertson formula (1925) there were tested about 200 samples for buckling test on I H T U circular and square section about Slenderness ratio 55 to 160, the imperfection is adopted $e_0/L = 1/1000$.SSRC (Structural stability research council) 1979, Deterministic $e_0/L = 1/1000$ adopted in CAN3-S16.1-M84 (1974, 1978, 1984), SANS Code, Probabilistic $e_0/L = 1/1470$.ECCS (European Convention for Constructional Steelwork) 1972 conducted more than 1000 buckling tests on I H T U circular and square section SR 55 to 160 more than 112 column curve produce, $e_0/L = 1/1000$. European Standard adopted the member imperfections for a compression member, this equivalent initial bow imperfection are specified in Table 4.

Table 4. Values of member initial bow imperfection

European Standard	Buckling curves	v_0/L
	a_0	-
	a	1/500
	b	1/250
	c	1/200
	d	1/150

It is found that the maximum permissible out-of-straightness generally is around 1/1,000, independent of country code or other design jurisdiction.

1.3. Residual stress measurement

Structural steel shapes and plates contain residual stresses that result primarily from non-uniform cooling after rolling. Flame cutting (also called oxygen cutting) introduces intense heat in a narrow region close to the flame-cut edge. As a result, the material in this region acquires properties that are significantly different from those of the base metal, and residual stresses develop that are often much higher than the yield stress of the parent material (Alpsten, Tall 1969a; Bjorhovde 1972). Systematic research on the effect of

residual stress on column strength was initiated in the late 1940s under the guidance of “Research Committee A” of the Column Research Council (Huber, Beedle 1954). This work continued through the early 1970s in extensive research projects, primarily at Lehigh University (Alpsten, Tall 1969b; Bjorhovde 1972). This experimental program mainly studied the longitudinal residual stress of equal angle steel sections. Three section sizes, including $L 50 \times 6$ mm, $L 60 \times 4.5$ mm and $L 65 \times 6$ [nominal width \times thickness of legs (mm)] are tested, and each section size had three section specimens; i.e., 9 sections were measured in total. Each section is labelled separately. In the first column of Table 3, R means the residual stress; L stands for the equal angle section, and the number following nominal width value of the specimens section, while last number is the serial number for the specimens with the same nominal section dimensions. The angles were cut 250 mm in length from longer sections, and 10 mm wide segments were marked along the cross-section. For each cross-sectional strip, 2 mm ϕ gage holes were drilled 150 mm apart in the longitudinal direction on each exposed face, as shown in Figure 5. After specimens were placed in an environmental chamber for 6 hours, initial gage length measurements were made using digital callipers precise to 0.0025 mm. Specimens were cut at the heel to separate their legs and then cut into the 150 \times 10 mm strips.

1.3.1. Demountable mechanical strain gauge

The demountable mechanical strain gauge (1/500 mm sensitivity) is a self-contained instrument consisting essentially of two coaxial tubes connected with a pair of elastic hinges (Fig. 6). Since the gages intended for repeated measurement at a series of stations rather than for fixed mounting at one station, consideration has been given to controlling accidental longitudinal forces which might be applied by the operator.

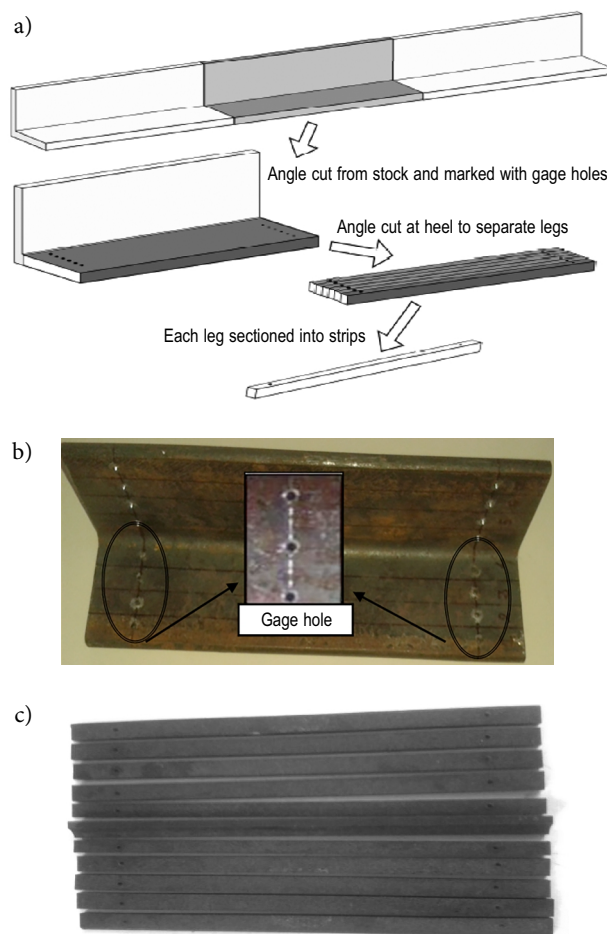

Fig. 5. a) sectioning procedure; b) gage marker patterns for residual stress specimens; c) sectioned residual stress specimens

For strain measurements, the contact points are inserted into the drilled holes which are 150 + 0.025mm apart. Motion between the two frame members is measured directly with a dial indicator.

A tensile coupon test is conducted and the steel yield strengths f_y for each specimen are summarized in Table 7. Residual stress normally expressed by stress factors in the design codes in many countries, such as those listed in Table 5. Similarly, in this study residual

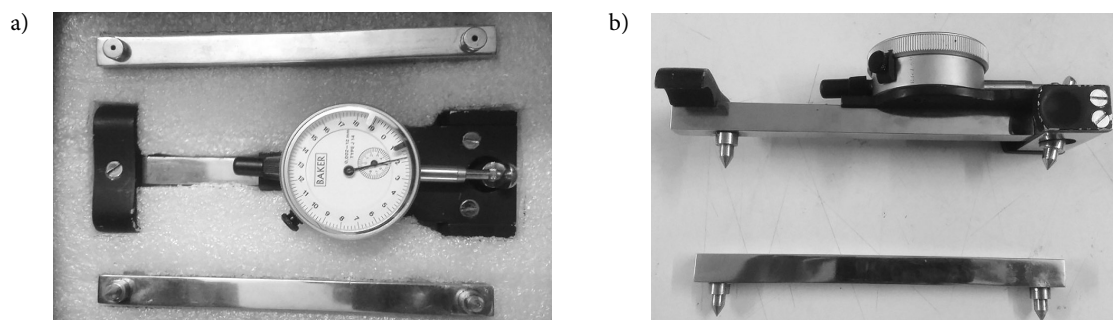

Fig. 6. Demountable mechanical strain gauge

stresses σ calculated from the experimental results were all divided by steel yield stress f_y and are listed in Table 6 as β ($\beta = \sigma r / f_y$), which is called the residual stress factor in this investigation.

1.3.2. Residual stress distribution

Based on the experimental results of all hot rolled equal angles section considered, the curve for 9 sections are presented in Figure 7 (for specimen RL50-1 to RL65-3), it is found that the residual stresses at the toe of the legs are compressive and those at the median region of the legs are tensile, which is analogous to the distribution models in the American, European, and Chinese steel structure design codes as shown in Figure 8.

1.3.3. Residual stress magnitudes

According to the American, European, and Chinese steel structure design codes, the residual stress distribution models of hot-rolled angles can be characterized by three values, including the maximum residual compressive stress factor at the toe of angle legs β_1 , the maximum residual tensile stress factor at the median region of legs β_2 , and the maximum residual compressive stress factor at corner β_3 , as shown in Figure 8.

In this investigation, there are only measurements at the outside surface of the angle leg at the corner as a result of the shortage of operating space, and the test results are relatively more discrete and not quite typical. The test results at other regions are all the average values of those at both surfaces of the legs, which are more typical. Therefore, the latter are mainly the focus here, and maximum residual compressive stress factor $\beta_{1\max}$ at the toe of the legs and maximum tensile $\beta_{2\max}$ at the median region of the legs are summarized in Table 6. Regarding maximum residual compressive stress factor β_3 at the corner of the legs, it is assumed to be equal to factor β_1 according to the existing residual stress models, as shown in Figure 8 and Table 6.

Comparing factors $\beta_{1\max}$ and $\beta_{2\max}$ of various angle sections in Table 6 with those listed in Table 5, it is found that the present test results were nearest to those adopted in the American, European, and Chinese steel structure design codes; i.e., the maximum of these two factors is 0.25, while the minimum of the latter is 0.22. Relationship between the residual stress and the width-thickness ratio of the angle legs are shown in Figure 9. The magnitude of the residual stresses can be as large as 65–105 MPa.

Table 5. Residual stress factors of equal angles adopted in American, European, and Chinese codes

No.	Design Codes	Factor β_1	Factor β_2	Factor β_3
1	American (Galambos 1998; Kitipornchai and Lee 1986a, b)	-0.30	0.30	-0.30
2	European (ECCS) 1976	-0.22	0.24	-0.25
3	Chinese (CDSSC) 1983	-0.22	0.24	-0.25
4	Chinese (CDSSC) 2003	-0.30	0.30	-0.30
5	Chinese (CDSSC) 2003	-0.25	0.25	-0.25
6	Chinese (CDSSC) 2003	-0.20	0.20	-0.20

Table 6. Nominal dimensions of specimens and test results

Specimen label	F_y (MPa)	β_1	$\beta_{1\max}$	β_2	$\beta_{2\max}$	b/t
RL50-1	348.32	-0.23	-0.23	0.22	0.22	8.33
RL50-2	351.28	-0.21		0.208		
RL50-3	349.78	-0.225		0.21		
RL60-1	346.02	-0.24	-0.24	0.224	0.23	13.33
RL60-2	347.23	-0.237		0.21		
RL60-3	348.95	-0.23		0.23		
RL65-1	351.89	-0.18	-0.22	0.23	0.25	10.83
RL65-2	350.75	-0.20		0.246		
RL65-3	348.56	-0.22		0.25		

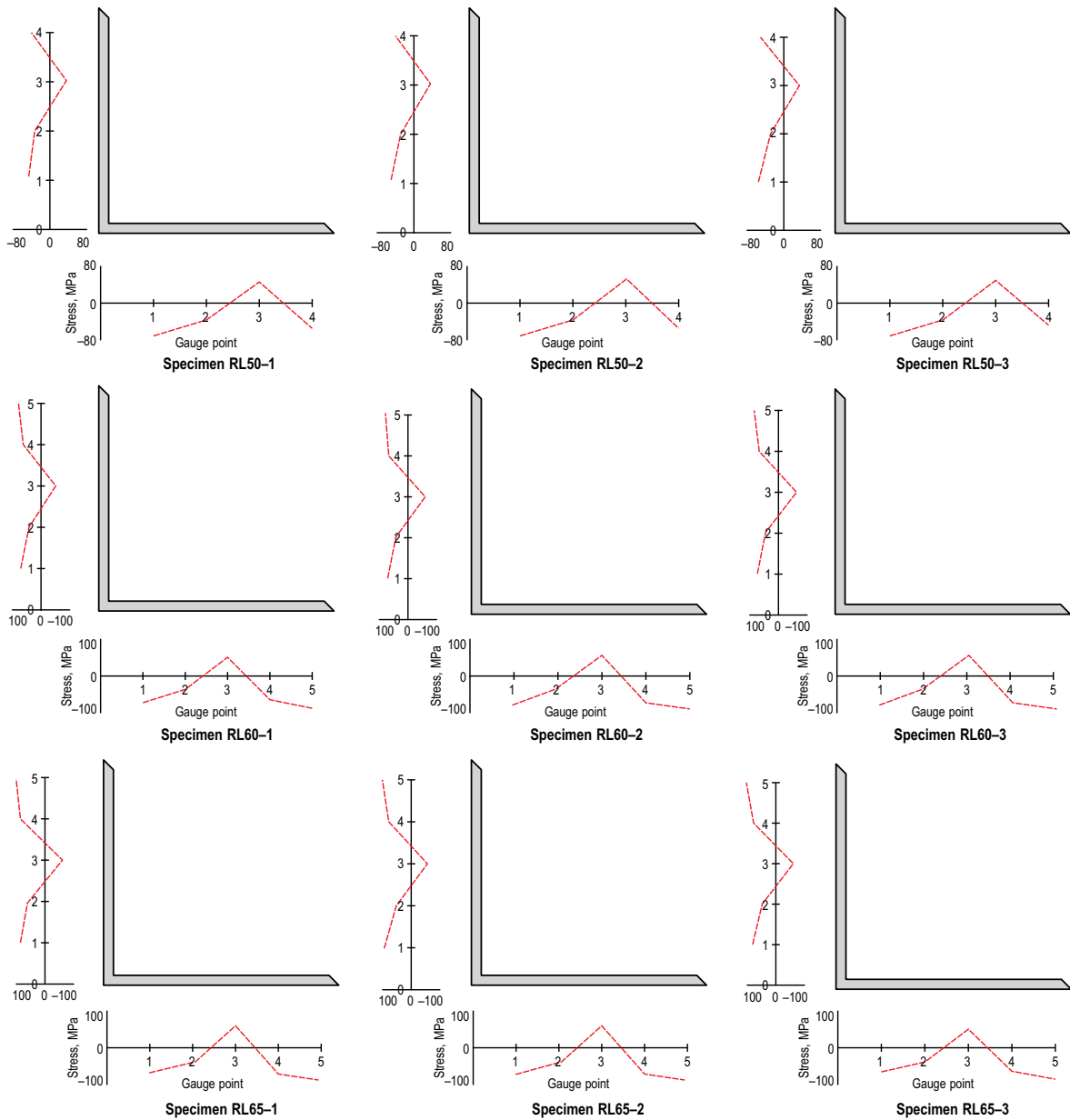

Fig. 7. Residual stress patterns for angle legs

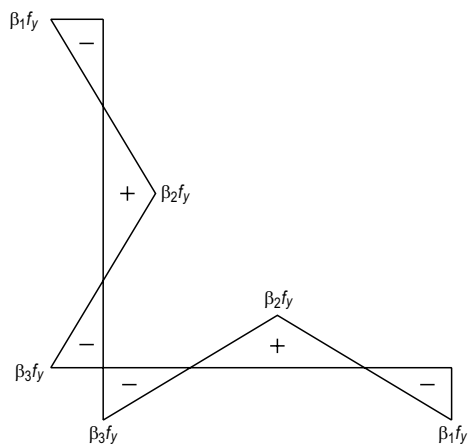

Fig. 8. Residual stress distribution model of hot rolled steel equal angle in American, European, and Chinese Codes

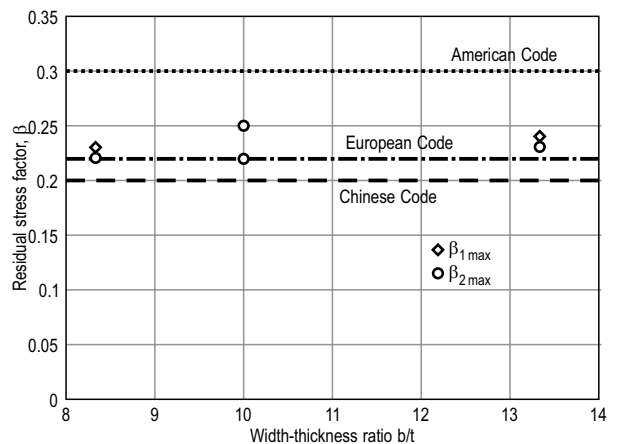

Fig. 9. Relationship between the residual stress and the width-thickness ratio of the angle legs

1.4. Compression tests

Yokoo, Wakabayashi, and Nonaka (1968) tested fifty-seven mild steel equal-leg angles under both concentric and eccentric axial loading.

1.4.1. Procedure of buckling test of single angle

The experimental program is carried out to study the behaviour of single-angle compression members connected with bolted and welded at both ends. The compression test is carried out in the Loading frame with using Hydraulic Jack for loading and Proving ring for measured critical load. Experimental Study of various angle sections with different sizes and lengths for Single angle and closely spaced double angle back to back with welded and bolted end connection is carried out by using same experimental set-up and repetitive the same procedure for calculating the ultimate load. Figure 10 shows the end arrangement for test specimen and the experimental set up are shown in Figure 11.

Testing procedure for measuring the buckling load is given below:

Step 1. The specimen is carefully aligned in the test setup.

Step 2. The loading line is passing from the centre of the hydraulic jack to eccentric with the centre of gravity of the test specimen. Due to the actual location of the end supports, the effective length of the specimen would be the centre-to-centre distance between the rollers of the end fixtures.

Step 3. After providing for a satisfactory alignment, a small load (about 1/15 to 1/20 of the estimated failure load) is kept applied to the specimen to preserve the aligned condition. It is considered to be the initial load on the tested member, and all measurement devices are initialized at this load level.

Step 4. The onset of yielding of each specimen is first estimated prior to the start of testing by determining the proportional limit stress. This equals the yield stress minus the measured maximum compressive re-



Fig. 11. a) Experimental set-up for compression test with loading frame; b) Experimental set-up for compression test

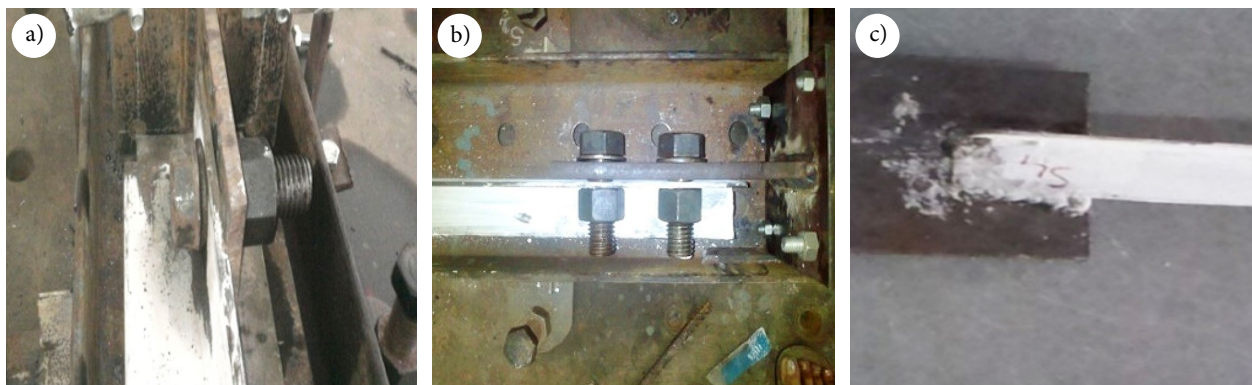

Fig. 10. End arrangements for single angle: a) single bolt; b) double bolt; c) welded

sidual stress of the specimen. This means that as long as the applied stress is smaller than the proportional stress, the behaviour is elastic. The converse is true for the inelastic range. Secondly, the start of the inelastic range is noticed by the reduction of the speed of testing as the stress passed from the elastic to the inelastic range. This is due to the fact that in the inelastic range the column deforms more rapidly than when in the elastic range.

Step 5. The specimen is tested with the hydraulic jack system, the load increment and the testing rate are determined individually. The maximum load and scale available with the hydraulic pump are the two major factors that controlled both of the above.

Step 6. The load increment ranged from 1 to 2 kN, depending on the size of the specimen. Each load increment is maintained until the readings for that increment are made. The incremental loading process and the recording of the corresponding readings are repeated until the maximum load of the member is reached.

However, due to the fact that the specimens are simply supported at both ends and are loaded axially, it is felt that it is safer not to load the specimens far beyond the maximum load. The load-deflection curves are given therefore does not show an appreciable post-buckling behaviour. More importantly, the main purpose of the tests is to obtain the buckling load and the mode of failure of the column, and not the behaviour of the column after buckling. Halting the test shortly

after the maximum load is reached therefore has no effect on the primary focus of the study.

Step 7. Careful attention is paid to the occurrence of any form of local buckling. To assist in this endeavour all specimens are whitewashed prior to testing. This is aid in determining the onset of any local buckling along with local yielding.

Step 8. Experimental study of various angle sections with different sizes and lengths for single angle and closely spaced double angle back to back with welded and bolted end connection is carried out by using same experimental set-up and repetitive the same procedure for calculating the ultimate load.

2. Comparison of experimental test results with IS 800:2007 buckling curves

After the testing of all specimens, buckling shapes are formed in angle section and the stresses developed in that section. These stress developed due to various failure pattern are shown in Figure 12. At the same time we get the division on proving ring dial gauge from that find out ultimate load for test specimen are given in Table 7 to 9 for single angle with one bolt, two bolt and welded connection. Sample data of Typical Load vs mid-height Deflection graph of test specimen for single angle are shown in Figure 13.

Experimental result for single angle of $L 50 \times 4$, $L 50 \times 6$, $L 60 \times 5$, $L 65 \times 6$ with slenderness ratio between 50 to 160 for bolted and welded connection are plot against IS 800:2007 column buckling curves are shown in Figure 14 to Figure 17.



Fig.12. Failure modes and stress pattern in test specimens:
a) flexural buckling; b) local buckling

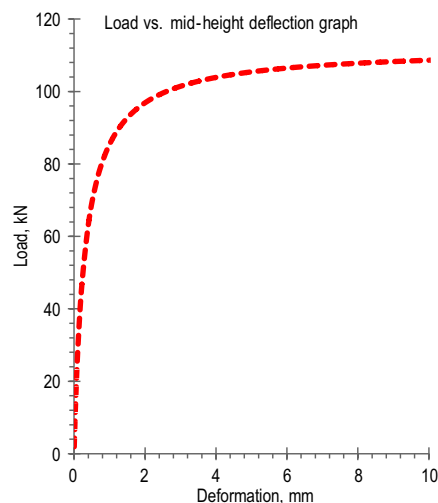

Fig.13. Load vs. mid-height deflection graph of test specimen

Table 7. Experimental test result for single bolted angle specimens

Specimen ID	Angle size mm	Slenderness ratio	Type of Failure Mode	Failure Load P_{exp} (kN)	Actual F_y (MPa)
S1A	L 50 × 4	62.36	FB	62.30	353.32
S1B	L 50 × 4	104.16	FB	38.20	353.32
S1C	L 50 × 4	154.64	FB	25.60	353.32
S2A	L 50 × 6	62.17	FB	73.50	351.08
S2B	L 50 × 6	114.56	FB	51.23	351.08
S2C	L 50 × 6	156.25	FB	39.62	351.08
S3A	L 60 × 5	68.96	FB	81.52	348.21
S3B	L 60 × 5	103.45	FB	49.78	348.21
S3C	L 60 × 5	155.17	LB ^b	38.56	348.21
S4A	L 65 × 6	71.43	FB	83.40	354.3
S4B	L 65 × 6	112.01	LB	65.82	354.3
S4C	L 65 × 6	158.73	FB	48.56	354.3

Notes: ^aFB = Flexural Buckling; ^bLB = Local Buckling

Table 8. Experimental test result for two bolted angle specimens

Specimen ID	Angle size mm	Slenderness ratio	Type of Failure Mode	Failure Load P_{exp} (kN)	Actual F_y (MPa)
S5A	L 50 × 4	62.36	FB	75.20	353.32
S5B	L 50 × 4	104.16	FB	52.29	353.32
S5C	L 50 × 4	154.64	FB	46.60	353.32
S6A	L 50 × 6	62.17	FB	87.50	351.08
S6B	L 50 × 6	114.56	FB	62.23	351.08
S6C	L 50 × 6	156.25	FB	50.23	351.08

Table 9. Experimental test result for welded angle specimens

Specimen ID	Angle size mm	Slenderness ratio	Type of Failure Mode	Failure Load P_{exp} (kN)	Actual F_y (MPa)
S7A	L 50 × 4	62.36	FB	71.20	353.32
S7B	L 50 × 4	104.16	FB	48.29	353.32
S7C	L 50 × 4	154.64	FB	42.60	353.32
S8A	L 50 × 6	62.17	FB	82.80	351.08
S8B	L 50 × 6	114.56	FB	57.21	351.08
S8C	L 50 × 6	156.25	FB	45.43	351.08

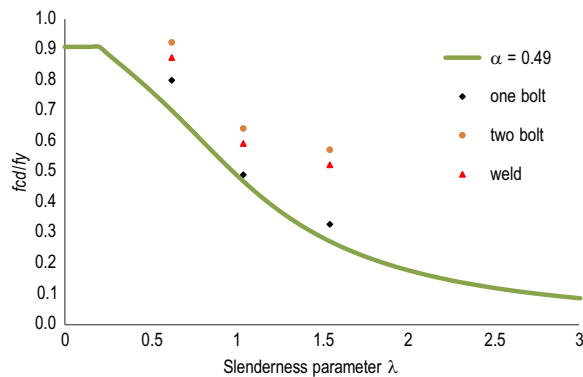

Fig.14. Comparisons of test result for L50 × 4 with IS 800-2007 curves ($F_y = 353.32$ MPa)

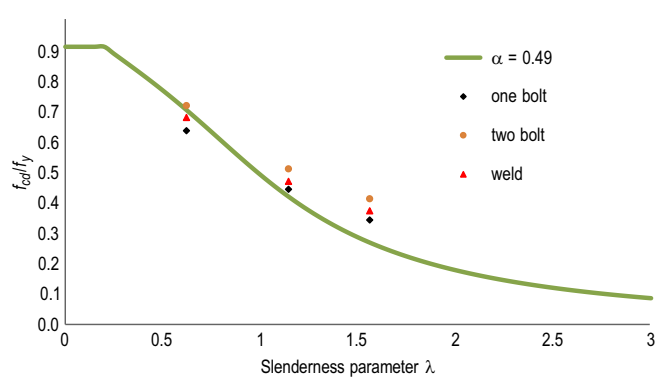

Fig. 15. Comparisons of test result for L50 × 6 with IS 800-2007 curves ($F_y = 351.08$ MPa)

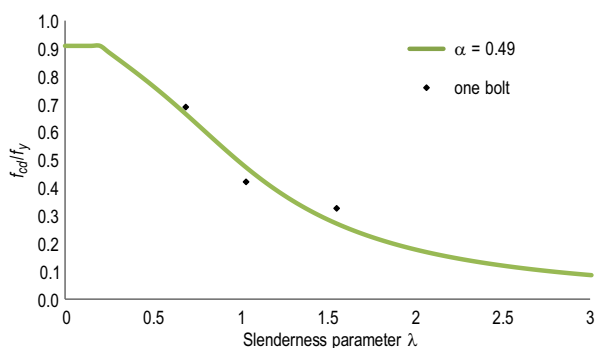

Fig. 16. Comparisons of test result for $L50 \times 6$ with IS 800-2007 curves ($F_y = 348.21$ MPa)

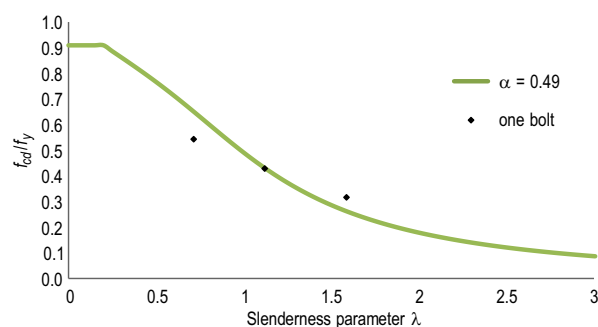

Fig. 17. Comparisons of test result for $L65 \times 6$ with IS 800-2007 curves ($F_y = 354.3$ MPa)

Conclusions

No symmetrical residual stresses were observed even for the equal legged angles. Maximum compressive residual stress is 24% of yield stress that is obtained from the tension coupon test. Maximum measured tensile residual stress is $(0.25F_y)$. The present test results were nearest to those adopted in the American, European, and Chinese steel structure design codes; i.e., the maximum of these two factors is 0.25, while the minimum of the latter is 0.22. The magnitude of the residual stresses can be as large as 65–105 MPa. For eccentrically loaded single angle, average value for the experimental to theoretical ratio is 0.8975, two bolt arrangements is 0.905, welded arrangement is 0.9238. The comparison of the test results with the design rules of IS 800:2007, the design capacity predicted by IS 800:2007 shows that the design capacities predicted by IS 800:2007 are more conservative compared with the test strength.

Acknowledgments

The research described in this paper was financially supported by the Technical Education Quality Improvement Programme (TEQIP-II). The authors are thankful to the Director, Visvesvaraya National Institute of Technology Nagpur for sanctioning the financial approval for the research project described in this paper.

References

- Adluri, S. M. R.; Madugula, M. K. S. 1992. Eccentrically loaded single angle struts, *Engineering Journal*, AISC 29(2): 59–66.
- Aydin, M. R. 2009. Analysis of equal leg single-angle section beams subjected to biaxial bending and constant axial compressive force, *Journal of Constructional Steel Research* 65(2): 335–341. <http://dx.doi.org/10.1016/j.jcsr.2008.04.009>
- Alpsten, G. A.; Tall, L. 1969a. *Residual stresses in heavy welded shapes*. Fritz Engineering Laboratory Report No. 337.12.
- Alpsten, G. A.; Tall, L. 1969b. *Residual stress measurements in thick steel plates*. Fritz Engineering Laboratory Report No. 337.13.
- Bjorhovde, R. 1972. Deterministic and probabilistic approaches to the strength of steel columns: PhD dissertation. Lehigh University, Fritz Laboratory Reports.
- BS 5950: 2000. *Code of Practice for the Design of Simple and Continuous Construction for Hot-Rolled Sections*. British Standard Institution, London.
- CAN3-S16.1-M84. 1984. *Steel Structures for Buildings (Limit States Design)*. Canadian Standards Association, Rexdale, Ontario.
- CAN3-S16.1: 1974. *Steel Structures for Buildings—Limit States Design*. Canadian Standards Association, Rexdale, Ontario, Canada.
- CAN3-S16.1-M78. 1978. *Steel Structures for Buildings—Limit States Design*. National Standard of Canada. Canadian Standards Association, Rexdale, Ontario, Canada.
- Elgaaly, M.; Davids, W.; Dagher, H. 1991. Behavior of single angle compression member, *Journal of Structural Engineering* 117(12): 3720–3741. [http://dx.doi.org/10.1061/\(ASCE\)0733-9445\(1991\)117:12\(3720\)](http://dx.doi.org/10.1061/(ASCE)0733-9445(1991)117:12(3720))
- Huber, A. W.; Beedle L. S. 1954. Residual stresses and the compressive strength of steel, *The Welding Journal* 33(12): 589–614.
- IS 2062: 2006. *Hot Rolled Low, Medium and High Tensile Structural Steel*. Bureau of Indian Standard, New Delhi.
- IS 800: 2007. *General Construction in Steel-Code of Practice*. Bureau of Indian Standard, New Delhi.
- Kennedy, J. B.; Murty, M. K. S. 1972. Buckling of steel angle and tee struts, *Journal of Structural Division* 98(11): 2507–2522.
- Kitipornchai, S.; Lee, H. W. 1984. *Inelastic experiments on angles and tee struts*. Research Report No. CE54, Department of Civil Engineering, University of Queensland, St. Lucia, Australia.
- Liu, Y.; Hui, L. 2008. Experimental study of beam-column behaviour of steel single angles, *Journal of Constructional Steel Research* 64(5): 505–514. <http://dx.doi.org/10.1016/j.jcsr.2007.11.002>
- Liu, Y.; Hui, L. 2010. Behaviour of steel single angles subjected to eccentric axial loads, *Canadian Journal of Civil Engineering* 37(6): 887–896. <http://dx.doi.org/10.1139/L10-028>

- Temple, M. C.; Sakla, S. S. S. 1995. Considerations for the design of single-angle compression members attached by one leg, in S. Kitipornchai, G. Hancock, M. A. Bradford (Eds.). *Proceedings of International Conference on Structural Stability and Design*. Rotterdam: Balkema, 107–112.
- Woolcock, S. T.; Kitipornchai, S. 1986. Design of single angle web struts in trusses, *Journal of Structural Engineering* (112)6: 1327–1345.
[http://dx.doi.org/10.1061/\(ASCE\)0733-9445\(1986\)112:6\(1327\)](http://dx.doi.org/10.1061/(ASCE)0733-9445(1986)112:6(1327))
- Yokoo, Y.; Wakabayashi, M.; Nonaka, T. 1968. *An experimental study on the buckling of angles*. Yawata Technical Report No. 265, Yawata Iron and Steel Co., Ltd., Tokyo, Japan, 8543–8563, 8759–8760.

Jyoti V. BHILAWÉ, PhD. Graduated in Civil Engineering in 2006 from Nagpur University. Research interests: steel structure, PEB structure.

Laxmikant M. GUPTA, PhD. Graduated in Civil Engineering in 1980 from Nagpur University. Research interest: prestressed steel structure.